

General tolerances ISO 2768-m						Index	Date	Visum	Modification	Index	Date	Visum	Modification
Basic-size	...6	> 6 ...30	> 30 ...120	>120 ...400	> 400 ...1000								
medium	±0.1	±0.2	±0.3	±0.5	±0.8								

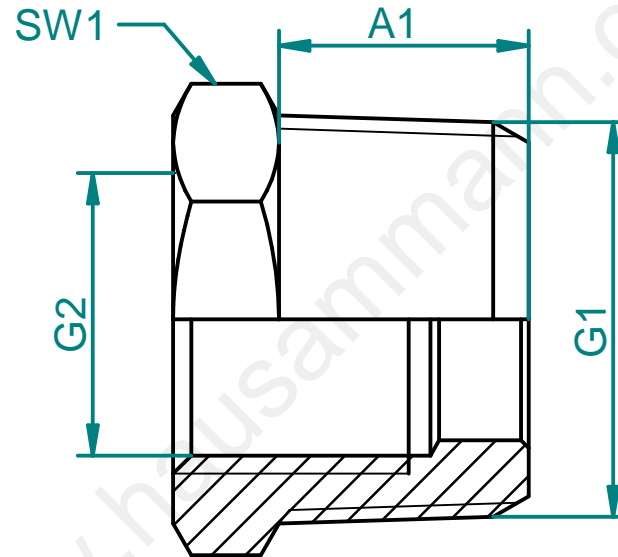

Specifications points D,K,H	
D= doc.points	
K= critical	
H= main	

		Material:			
		Messing blank			
		Scale			
		2:1			
		plotted		Date	Visum
		checked		15.04.11	E.Z
		38.592		Format	Index
		Solid Edge		A4	00
Accord-draw.no.:	Origin-draw.no.:	© 2010, Für dieses Dokument behalten wir uns alle Rechte vor.			
Replacement for:	© 2 010, Nous nous reservons tous les droits sur ce document		© 2 010, We reserve all rights in connection with this document		

